

Grandstream Networks, Inc.

DP760

DECT Repeater

User Manual



COPYRIGHT

©2021 Grandstream Networks, Inc. <http://www.grandstream.com>

All rights reserved. Information in this document is subject to change without notice. Reproduction or transmittal of the entire or any part, in any form or by any means, electronic or print, for any purpose without the express written permission of Grandstream Networks, Inc. is not permitted.

The latest electronic version of this guide is available for download here:

<http://www.grandstream.com/support>

Grandstream is a registered trademark and Grandstream logo is a trademark of Grandstream Networks, Inc. in the United States, Europe and other countries.

CAUTION

Changes or modifications to this product not expressly approved by Grandstream, or operation of this product in any way other than as detailed by this guide, could void your manufacturer warranty.

WARNING

Please do not use a different power adaptor with devices as it may cause damage to the products and void the manufacturer warranty.



GNU GPL INFORMATION

DP760 firmware contains third-party software licensed under the GNU General Public License (GPL). Grandstream uses software under the specific terms of the GPL. Please see the GNU General Public License (GPL) for the exact terms and conditions of the license.

Grandstream GNU GPL related source code can be downloaded from Grandstream Website from:
<http://www.grandstream.com/support/faq/gnu-general-public-license/gnu-gpl-information-download>



Table of Contents

DOCUMENT PURPOSE	8
CHANGE LOG	9
Firmware Version 1.0.17.1	9
Firmware Version 1.0.15.15	9
Firmware Version 1.0.15.6	9
Firmware Version 1.0.15.3	9
Firmware Version 1.0.15.2	9
Firmware Version 1.0.13.8	9
Firmware Version 1.0.13.0	9
Firmware Version 1.0.11.12	9
Firmware Version 1.0.11.4	9
Firmware Version 1.0.11.2	9
Firmware Version 1.0.9.9	10
Firmware Version 1.0.9.1	10
Firmware Version 1.0.7.5	10
Firmware Version 1.0.4.10	10
Firmware Version 1.0.4.7	10
Firmware Version 1.0.4.2	10
Firmware Version 1.0.3.40	10
Firmware Version 1.0.3.34	10
WELCOME	11
PRODUCT OVERVIEW	12
Feature Highlights.....	12
DP760 Technical Specifications.....	12
GETTING STARTED	14
Equipment Packaging	14
Connecting DP760.....	14



<i>Connecting via AC power</i>	15
<i>Connecting via PoE</i>	15
DP760 Implementation Architecture	15
DP760 LED Patterns.....	16
CONFIGURATION GUIDE	18
Configuration via Web Browser	18
<i>Accessing the Web GUI using UPnP Feature</i>	18
<i>Accessing the Web GUI using DP750 Repeater Management Mode</i>	19
<i>Saving the Configuration Changes</i>	19
Web GUI Access Level Management	19
<i>Changing User Level Password</i>	20
<i>Changing Admin Level Password</i>	21
<i>Changing HTTP/HTTPS Web Access Port</i>	22
Web Configuration Definitions	22
<i>Status Page Definitions</i>	23
<i>DECT Page Definitions</i>	25
<i>Network Settings</i>	25
<i>Maintenance Page Definitions</i>	26
Rebooting from Remote Location	32
DP760 DECT REPEATER ASSOCIATION WITH DP750	33
Enabling Repeater Mode on DP750	33
DP760 DECT Repeater Association	33
<i>Auto Association</i>	34
<i>Manual Association</i>	35
<i>Use DP750 Repeater Management to Associate DP760</i>	36
DP760 DECT REPEATER DISSOCIATION	39
Using DP760 Web GUI	39
Using Page Button	39
Using Repeater Management Mode on DP750.....	40



UPGRADING AND PROVISIONING	41
Firmware Upgrade Procedure	41
Upgrading via Local FTP/HTTP Servers	42
RESTORE FACTORY DEFAULT SETTINGS	42
Resetting DP760 Repeater Station.....	44
<i>Via Reset Button</i>	44
<i>Via Web GUI</i>	44
EXPERIENCING THE DP760	45



Table of Tables

Table 1: DP760 Features at a Glance	12
Table 2: DP760 Technical Specifications	12
Table 3: Equipment Packaging	14
Table 4: DP760 LED Patterns	17
Table 5: Default Passwords.....	19
Table 6: Status Pages Definitions	23
Table 7: DECT Page Definitions.....	25
Table 8: Network Settings Pages Definitions	25
Table 9: Maintenance Pages Definitions.....	26

Table of Figures

Figure 1: DP760 Package Content	14
Figure 2: DP760 Back View	14
Figure 3: Connecting the Repeater Station.....	15
Figure 4: Star Mode Configuration	16
Figure 5: DP760 LED Patterns	16
Figure 6: DP760 UPnP Discovery	18
Figure 7: User Level Password	20
Figure 8: Admin Level Password	21
Figure 9: Web Access Port.....	22
Figure 10: Enable Repeater Mode	33
Figure 11: Repeater Status – Associated (Auto Association)	34
Figure 12: Repeater Status – Associated (Manual Association).....	36
Figure 13: Repeater Associated Status	37
Figure 14: DECT Repeater Status on DP750	38
Figure 15: DECT Repeater Status on DP750	39
Figure 16: DECT Repeater Status on DP750	40
Figure 17: Firmware Upgrade Page.....	42



DOCUMENT PURPOSE

This document describes how to configure DP760 DECT Repeater via Web GUI menu. The intended audiences of this document are VoIP administrators.

Please visit <http://www.grandstream.com/support> to download the latest DP760 User Manual.

This guide covers following topics:

- [Product Overview](#)
- [Getting Started](#)
- [Configuration Guide](#)
- [DP760 DECT Repeater Association with DP750](#)
- [DP760 DECT Repeater Dissociation](#)
- [Upgrading and Provisioning](#)
- [Restore Factory Default Settings](#)



CHANGE LOG

This section documents significant changes from previous versions of administration guide for DP760. Only major new features or major document updates are listed here. Minor updates for corrections or editing are not documented here.

Firmware Version 1.0.17.1

- No major changes

Firmware Version 1.0.15.15

- No major changes

Firmware Version 1.0.15.6

- No major changes

Firmware Version 1.0.15.3

- No major changes

Firmware Version 1.0.15.2

- No major changes

Firmware Version 1.0.13.8

- No major changes.

Firmware Version 1.0.13.0

- No major changes.

Firmware Version 1.0.11.12

- No major changes.

Firmware Version 1.0.11.4

- No major changes.

Firmware Version 1.0.11.2

- No major changes.



Firmware Version 1.0.9.9

- No major changes.

Firmware Version 1.0.9.1

- No major changes.

Firmware Version 1.0.7.5

- No major changes.

Firmware Version 1.0.4.10

- No major changes.

Firmware Version 1.0.4.7

- No major changes.

Firmware Version 1.0.4.2

- No major changes.

Firmware Version 1.0.3.40

- Added support for automatic upgrade and provisioning be triggered at a random time in every certain day. [Automatic Upgrade]

Firmware Version 1.0.3.34

- This is the initial version for DP760.



WELCOME

The DP760 is a powerful DECT Repeater that auto associates to Grandstream DP750 Base Station to offer extended mobility to business and residential users. It extends an additional range of 300 meters outdoors and 50 meters indoors to give users the freedom to move around their work or home space, delivering efficient flexibility. This DECT Repeater relays up to two concurrent HD calls. The Ethernet connection provides PoE for convenient installation and variety of remote features including provisioning, status monitoring and firmware upgrade. When paired with Grandstream DP750 DECT VoIP base station and DP720 handsets, the DP760 is a powerful DECT Repeater that allows any business or residential user to create a cordless VoIP solution of extended coverage.



PRODUCT OVERVIEW

Feature Highlights

The following table contains the major features of the DP760:

Table 1: DP760 Features at a Glance

 <p>DP760</p>	<ul style="list-style-type: none"> • 5 Stations in star. • 2 Concurrent HD calls. • PoE power support. • 300m range outdoor / 50m range indoor. • Automatic or manual association to base station.
---	---

DP760 Technical Specifications

The following table resumes all technical specifications including the protocols / standards supported, voice codecs, telephony features, languages and upgrade/provisioning settings for DP760 DECT Repeater.

Table 2: DP760 Technical Specifications

Air Interface	<p>Telephony standards:</p> <ul style="list-style-type: none"> ▪ DECT EN 301 406:2001 ▪ DECT GAP TBR22 EN 300 444:2001 ▪ DECT DECT EN 300 700 ▪ CAT-iq TS 102 527 <p>Frequency bands:</p> <ul style="list-style-type: none"> ▪ 1880 – 1900 MHz (Europe) ▪ 1920 – 1930 MHz (US) ▪ 1910 – 1920 MHz (Brazil) <p>Number of channels: 10 (Europe), 5 (US, Brazil).</p> <p>Range: up to 300 meters outdoor and 50 meters indoor.</p>
Peripherals	<p>5 LED indicators: Power, Network, Association, Activity, DECT</p> <p>Reset button, Pairing/Paging button</p> <p>One 10/100 Mbps auto-sensing Ethernet port with integrated PoE</p>
Protocols/Standards	TCP/IP/UDP, HTTP/HTTPS, ARP/RARP, ICMP, DNS (A record, SRV, NAPTR), DHCP, PPPoE, SSH, TFTP, NTP, SIMPLE, LLDP-MED.
Voice Codecs	G.722 codec for HD audio and G.726 codec for narrow band audio.

Telephony Features	Plug-n-Play, auto association, auto region detection and seamless call handover.
Security	User and administrator level access control, MD5 and MD5-sess based authentication, 256-bit AES encrypted configuration file, HTTPS, 802.1x media access control, DECT authentication.
Multi-language	English, Czech, German, Spanish, French, Arabic, Hebrew, Italian, Russian, Netherlands, Japanese, Polish, Chinese Simple, Chinese Tradition, Korean, Portuguese, Slovakian, Serbian, Swedish and Turkish.
Upgrade/ Provisioning	Firmware upgrade via FTP/FTPS/HTTP/HTTPS.
Association	Up to 5 stations in star. Automatic or manual association to base station.
Power & Green Energy Efficiency	<ul style="list-style-type: none"> • Universal Power Supply: Input AC 100-240V 50/60Hz, Output 5VDC 1A, Micro-USB connection. • PoE: IEEE802.3af Class 1, 0.44W–3.84W.
Package Content	DECT Repeater Unit, Universal Power Supply, Ethernet cable, Quick Installation Guide, GPL statement
Dimensions	28.5 mm (H) x 130 mm (W) x 90 mm (D).
Weight	DECT Repeater unit: 143g; Universal Power Supply: 50g; Package: 360g.
Temperature and Humidity	Operation: -10° to 50°C (14° to 122°F); Storage: -20° to 60°C (-4° to 140°F). Humidity: 10% to 90% non-condensing.
Compliance	FCC: Part 15D, Part 15B, MPE CE: EN60950, EN301489-1-6, EN301406, EN50385 RCM: AS/NZS60950 ANATEL: #2288-16-9452

GETTING STARTED

This chapter provides basic installation instructions including the list of the packaging contents and description of the LED patterns.

Equipment Packaging

Table 3: Equipment Packaging

DP760
<ul style="list-style-type: none"> • 1 DECT Unit. • 1 Universal power supply 5V. • 1 Ethernet cable. • 1 Quick Installation Guide. • 1 GPL Statement.

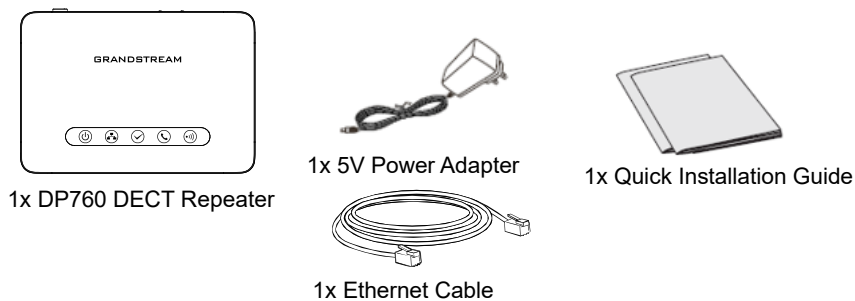

Figure 1: DP760 Package Content

Note: Check the package before installation. If you find anything missing, contact your system administrator.

Connecting DP760

To setup the DP760 DECT Repeater, please follow the steps below:

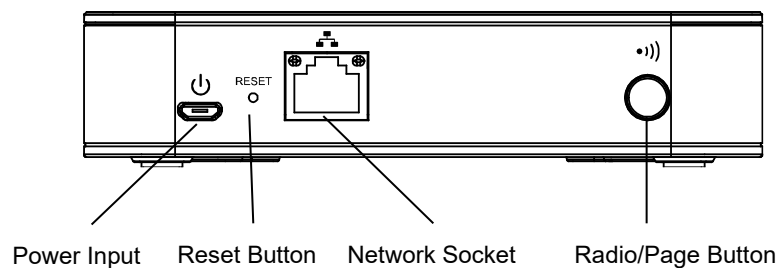

Figure 2: DP760 Back View

There are two options to connect DP760 DECT Repeater, either with the AC power or Power over Ethernet (PoE)

Connecting via AC power

1. Connect the micro-USB connector into the related port on the repeater station and connect the other end of the power adapter into an electrical power outlet.
2. Connect the supplied Ethernet cable between the Internet port on the DP760 DECT Repeater and the Internet port in your network or the switch/hub device port.

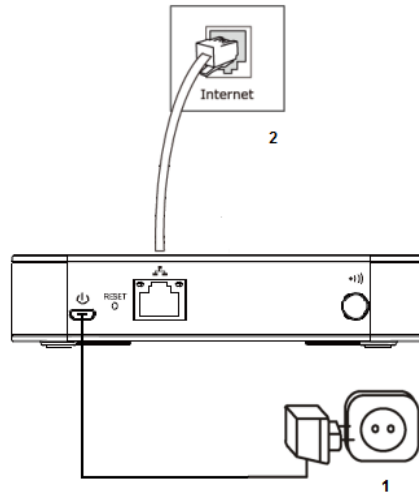

Figure 3: Connecting the Repeater Station

Connecting via PoE

To connect the DP760 DECT Repeater using PoE, you need to connect the Ethernet cable provided (or 3rd party network cable) between the Network Socket on the repeater station to Ethernet port of your PoE switch/hub.

DP760 Implementation Architecture

The DP750 Base Station can support up to 5 DP760 DECT Repeater stations to extend the coverage area of the base in all directions, including through floors and ceilings using star architecture as displayed on the following diagrams.

When a repeater powers on, it searches for signals from the base and any other repeaters registered to the same base. The repeater will automatically connect to the first available signal.

The base can hand-off calls to the repeaters as the user moves from one coverage area to another. When connected to the repeater, the DP720 handsets operate as if it is connected to the base, and the hand-off from the base to the repeater can be completely invisible to the end user, even during an active call.

Note:

- DP760 can relay up to 2 concurrent calls.



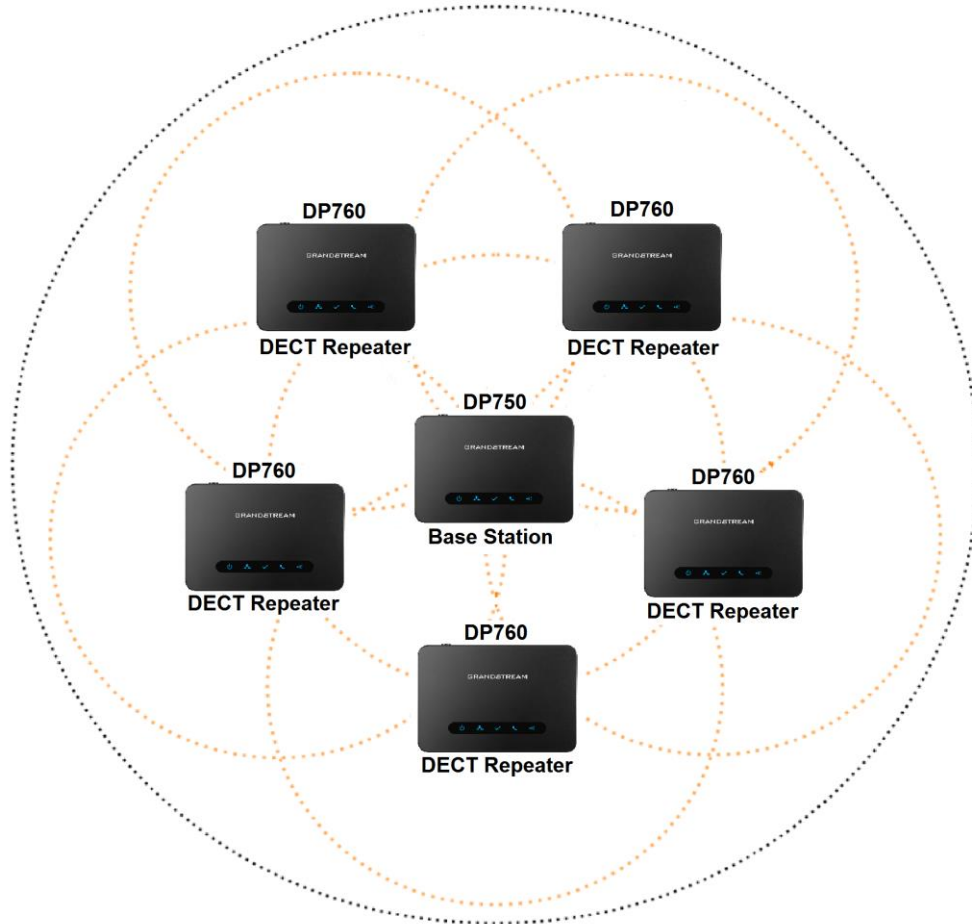

Figure 4: Star Mode Configuration

In star mode configuration, the coverage area of the repeaters should overlap the coverage area of the base station.





DP760 LED Patterns

The DP760 has 5 LED lights. Please refer to following table describing the status of each LED.



Figure 5: DP760 LED Patterns

Table 4: DP760 LED Patterns

LED	Status
	Indicates Power ON/OFF.
	Indicates access to the network. <ul style="list-style-type: none"> • Solid ON: When there is access to the network. • Blinking: If there is no access to the network.
	Indicates status of the association between DP760 and DP750 <ul style="list-style-type: none"> • Blinking: When the DECT station is scanning for available RFPs. • Solid ON: When the association between DECT repeater and Base station is operational.
	Indicates status of the association between DP760 and DP750 during calls. <ul style="list-style-type: none"> • Solid ON: When there are no active calls and the association between DECT repeater and Base station is operational. • Blinking: During active calls.
	Indicates status of the association link between the DP760 and DP750. <ul style="list-style-type: none"> • Solid ON: When the association between DECT and Base station is operational, and link is excellent. • Blinking: <ul style="list-style-type: none"> ▪ Long ON, 1x short OFF if the association link is good. ▪ Long ON, 2x short OFF if the association link is weak. ▪ Long ON, 3x short OFF if the association link is poor

CONFIGURATION GUIDE

The DP760 can be configured via the Web GUI embedded using a Web browser. By default, DP760 is configured to obtain IP address from DHCP server where the unit is located and can be discovered using UPnP feature (by default enabled).

Configuration via Web Browser

The DP760 embedded Web server responds to HTTP/HTTPS GET/POST requests. Embedded HTML pages allow a user to configure the DP760 through a Web browser such as Google Chrome, Mozilla Firefox and Microsoft Internet Explorer.

Note: If DP760 has a known IP, users can access to its Web GUI by entering the IP address in their Web browser on a device connected to same network.

Accessing the Web GUI using UPnP Feature

DP760 supports UPnP feature (by default enabled) for auto discovery by computers in same network. Please refer to following steps to access DP760 Web GUI:

1. Power on DP760 and connect it to the network.
2. Connect a computer to same network as DP760. (The computer must be connected to the same sub-network as the DP760. This can be easily done by connecting the computer to the same hub or switch as the DP760).
3. Access **Network** directory on the computer.
4. Locate **DP760 - <MAC Address>** device and double click on it to access Web GUI.

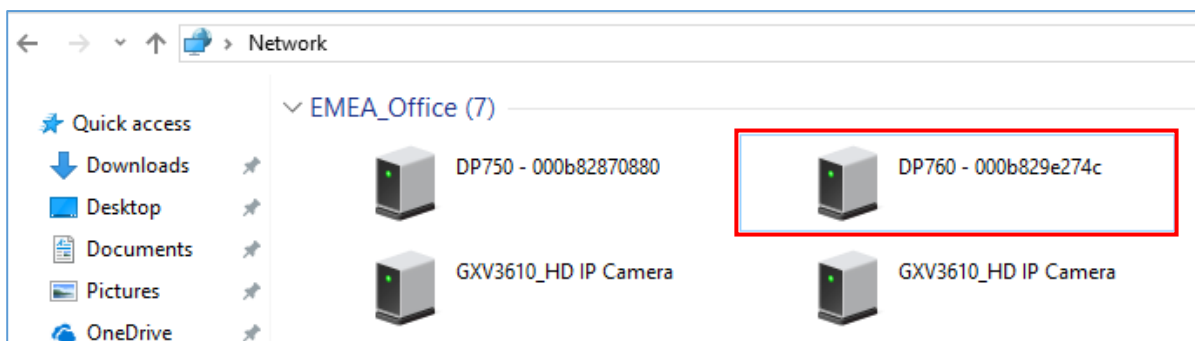

Figure 6: DP760 UPnP Discovery

5. Enter admin's username and password and press Login button to access the configuration menu. (Starting HW version 1.3A the default admin username is 'admin' while the admin password is the random password that can be found on the sticker at the back of the unit. For lower hardware versions; the default username and password are: admin/admin)

Accessing the Web GUI using DP750 Repeater Management Mode

The repeater management mode on the DP750 allows managing discovered / paired repeater stations and accessing the DP760 Web GUI from DP750 Web GUI. Please refer to following steps to access DP760 Web GUI using DP750 repeater management mode:

1. Access the Web GUI of your DP750 using the admin's username and password. (Starting HW version 1.7A the default admin username is 'admin' while the admin password is the random password that can be found on the sticker at the back of the unit. For lower hardware versions; the default username and password are: admin/admin).
2. Navigate to **DECT** → **General Settings** and set **Enable Repeater Management** to Yes.
3. Press **Save and Apply** button, then reboot the unit to apply the new settings.
4. After finishing the reboot, access again the DP750 Web GUI.
5. Navigate to **Status** → **DECT Repeater Status**.
6. Access the discovered or paired repeater Web GUI by clicking on its IP address.
7. You will be redirected to login page of the repeater, enter admin's username and password and press **Login** button to access the configuration menu.

Saving the Configuration Changes

After users make changes to the configuration, pressing the **Save** button will save but not apply the changes until the **Apply** button on the top of Web GUI page is pressed. Users can instead directly press the **Save and Apply** button. We recommend rebooting or powering cycle the device after applying all changes.

Web GUI Access Level Management

There are two default passwords for the login page:

User Level	Username	Password	Web Pages Allowed
End User Level	user	123	Status, Network Settings and Maintenance pages
Administrator Level	admin	The random password that can be found on the sticker at the back of the unit starting from HW version 1.3A. For lower hardware versions, the admin password is 'admin'.	All pages

Table 5: Default Passwords

The password is case sensitive with a maximum length of 25 characters.



Note: When accessing the Web GUI with normal user level, **Advanced Settings** page will be hidden.

When changing any settings, always **SUBMIT** them by pressing the **Save** or **Save and Apply** button on the bottom of the page. If using the **Save** button, after making all the changes, click on the **Apply** button on top of the page to submit. After submitting the changes in all the Web GUI pages, reboot DP760 to have the changes take effect if necessary; most of the options under the **Maintenance** page require a reboot.

Changing User Level Password

1. Access the Web GUI of your DP760 using the admin's username and password. (Starting HW version 1.3A the default admin username is 'admin' while the admin password is the random password that can be found on the sticker at the back of the unit. For lower hardware versions; the default username and password are: admin/admin).
2. Press **Login** to access your settings.
3. Go to **Maintenance** → **Web/SSH Access**.
4. In **Web/SSH Access** page, locate **User Password** section:
 - a. Type in your new user password in **New Password** field.
 - b. Type in again same entered password in **Confirm Password** field.
5. Press **Save and Apply** to save your new setting.

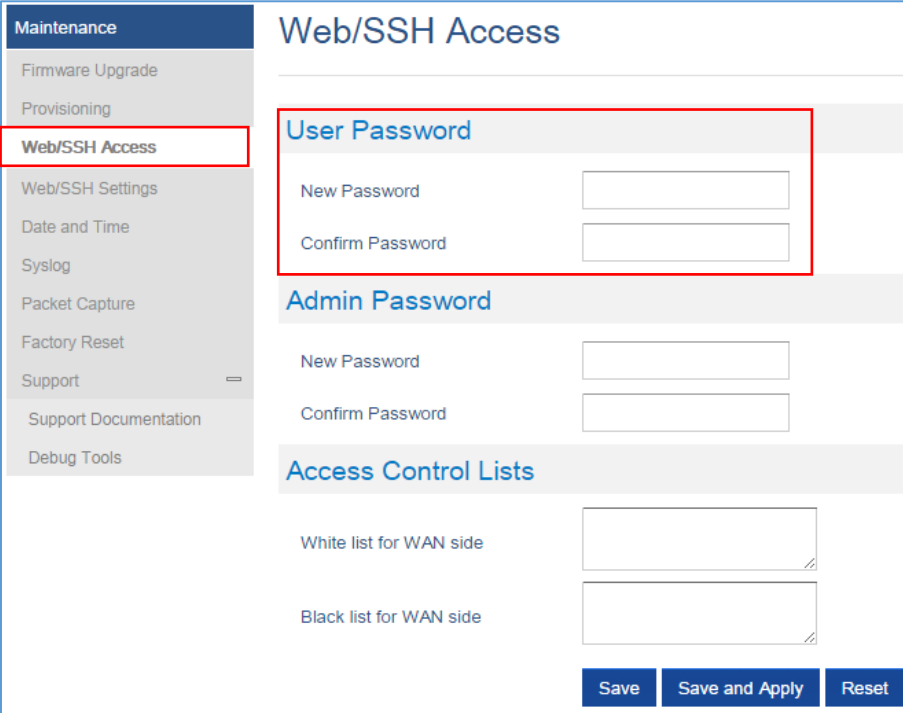

The screenshot shows the 'Web/SSH Access' configuration page. On the left is a navigation menu with 'Web/SSH Access' selected. The main content area has three sections: 'User Password' (highlighted with a red box), 'Admin Password', and 'Access Control Lists'. Each section has input fields for 'New Password' and 'Confirm Password'. At the bottom right are three buttons: 'Save', 'Save and Apply', and 'Reset'.

Figure 7: User Level Password

Note: DO NOT USE same password for both user and admin accounts.

Changing Admin Level Password

1. Access your DP760 DECT Repeater Web GUI by entering its IP address in your favorite browser.
2. Enter your admin's username and password. (Starting HW version 1.3A the default admin username is 'admin' while the admin password is the random password that can be found on the sticker at the back of the unit. For lower hardware versions; the default username and password are: admin/admin)
3. Press **Login** to access your settings.
4. Go to **Maintenance** → **Web/SSH Access**.
5. In **Web/SSH Access** page, locate **Admin Password** section:
 - a. Type in your new Admin Password in **New Password** field.
 - b. Type in again same entered password in **Confirm Password** field.
6. Press **Save and Apply** to save your new setting.

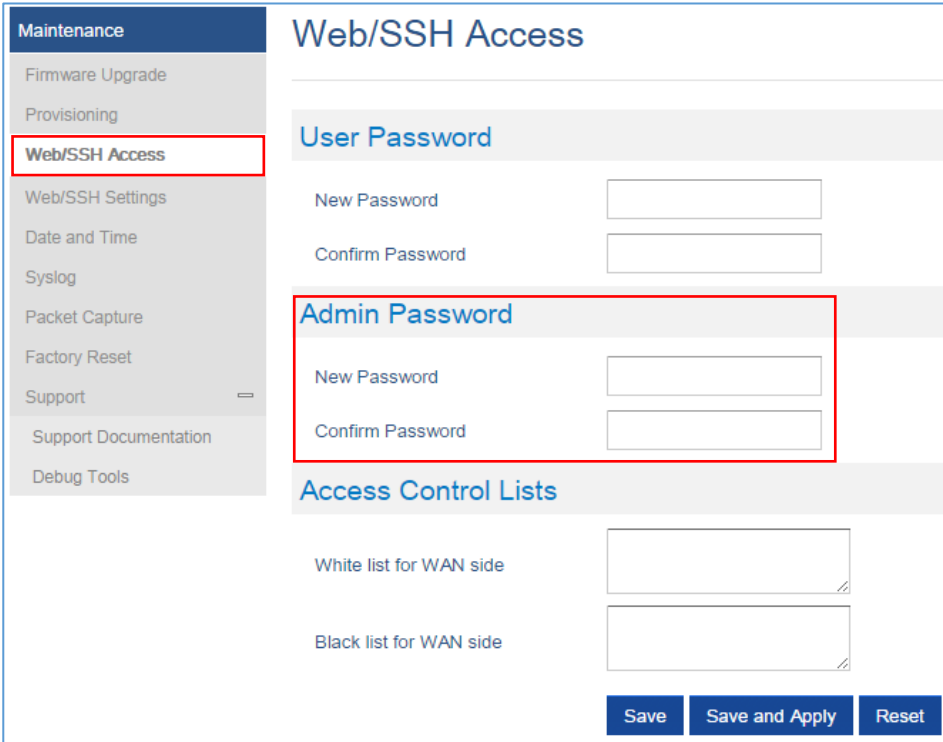

The screenshot shows the 'Web/SSH Access' configuration page. The left sidebar has 'Web/SSH Access' selected. The main content area has three sections: 'User Password', 'Admin Password', and 'Access Control Lists'. The 'Admin Password' section is highlighted with a red box and contains two input fields: 'New Password' and 'Confirm Password'. The 'User Password' section also has two input fields: 'New Password' and 'Confirm Password'. At the bottom, there are three buttons: 'Save', 'Save and Apply', and 'Reset'.

Figure 8: Admin Level Password

Note: DO NOT USE same password for both user and admin accounts.

Changing HTTP/HTTPS Web Access Port

1. Access your DP760 DECT Repeater Web GUI by entering its IP address in your favorite browser.
2. Enter your admin's username and password. (Starting HW version 1.3A the default admin username is 'admin' while the admin password is the random password that can be found on the sticker at the back of the unit. For lower hardware versions; the default username and password are: admin/admin).
3. Press **Login** to access your settings.
4. Go to **Maintenance** → **Web/SSH Settings**.
5. In **Web/SSH Settings** page, locate **HTTP / HTTPS Web Port** field and change it to your new HTTP/HTTPS port.

Note: By default, the HTTP port is 80 and HTTPS port is 443.

6. Select the **Web Access Mode** depending on desired protocol (HTTP or HTTPS).
7. Press **Save and Apply** to save your new setting.

Note: A reboot is required for this change to take effect.

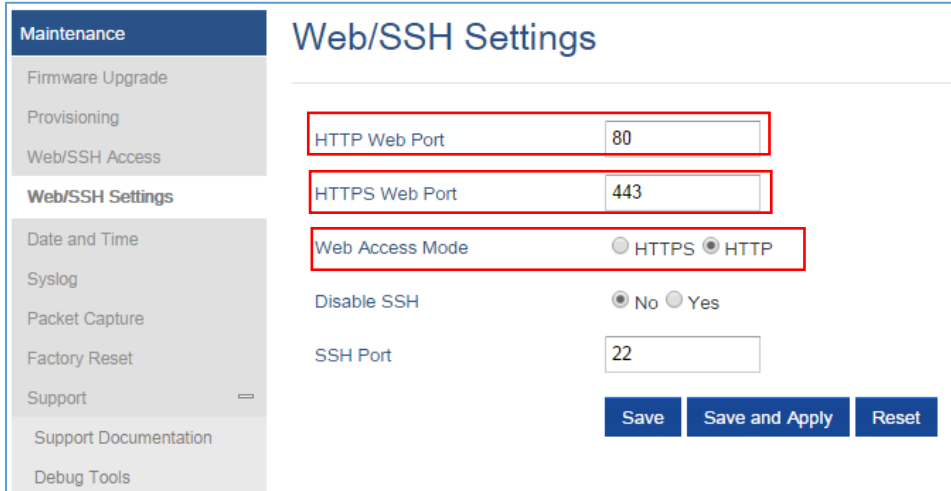

Field	Value
HTTP Web Port	80
HTTPS Web Port	443
Web Access Mode	<input type="radio"/> HTTPS <input checked="" type="radio"/> HTTP
Disable SSH	<input checked="" type="radio"/> No <input type="radio"/> Yes
SSH Port	22

Figure 9: Web Access Port

Web Configuration Definitions

This section describes DP760 options available in its Web GUI. As mentioned, you can log in as an administrator or an end user.

- **Status:** Display the system info, network status, DECT status options.
- **DECT:** Configure DECT general settings, repeater name and RFPI manual configuration.
- **Network Settings:** Configure network basic and advanced settings.

- **Maintenance:** Configure upgrading and provisioning, Web/SSH access, date and time, and syslog, packet capture and factory reset settings.

Status Page Definitions

Table 6: Status Pages Definitions

DECT Repeater Status	
Repeater Name	Displays name of DECT repeater. Default is DP760_[last 6 digit of MAC address] .
Repeater FW Version	Shows firmware version of repeater station.
Repeater DECT RF Region	Indicates region of repeater station. Example: EU, US, Auto...
Repeater Status	Status Describes the repeater status: <ul style="list-style-type: none"> • Scanning for available RFPs: DP760 is scanning and searching for available RFPs (Radio Fixed Part Identity) address. • Repeater is searching for the requested RFP: DP760 DECT repeater is searching for DP750 base station configured RFPI. (During manual association) • Repeater is in normal operation: DP760 DECT repeater is operational and associated with the DP750. <p>Note: The message “Repeater is operational after auto configuration procedure first time” appears briefly during DP760/DP750 association.</p>
	Signal Strength Displays the signal strength of the DECT repeater.
	Number of Active Calls Displays number of active calls on the DECT repeater.
Global Functions	<ul style="list-style-type: none"> • Base Station RFPI Address: Displays the RFPI address of the associated base station. • Disconnect: Disconnect the DP760 DECT Repeater from the DP750 Base Station.



Network Status	
MAC Address	Shows Device ID in hexadecimal format. This is needed by network administrators for troubleshooting. The MAC address will be used for provisioning and can be found on the label on original box and on the label located on the bottom panel of the device.
IP Address Mode	Indicates used IP address mode: DHCP, Static IP or PPPoE.
IP Address	Displays assigned IP address. Example: 192.168.5.110
Subnet Mask	Displays assigned subnet mask. Example: 255.255.255.0
Gateway	Displays assigned default gateway. Example: 192.168.5.1
PPPoE Link Up	Indicates PPPoE connection status.
DNS Server 1	Shows assigned DNS server address 1. Example: 8.8.8.8
DNS Server 2	Shows assigned DNS server address 2. Example: 8.8.4.4
System Info	
Product Model	Displays product model info. Default is DP760 .
Part Number	Shows product part number. Example: 9610003814A (last 2 digits show HW version, in this example 14A for HW version 1.4A).
Software Version	<ul style="list-style-type: none"> • Firmware Status: Displays the status of the firmware loaded. • Check for new firmware: Check configured server for most recent firmware version and compare to current version. After pressing button, you must reload or refresh this page to display status and check firmware availability. • Boot: Specifies Boot version. • Core: Specifies Core version. • Base: Specifies Base version. • Prog: Specifies Prog version. This is the main firmware release number, which is always used for identifying the software system of the DP760. • Locale: Specifies Locale version. • Recovery: Specifies Recovery version.
System Up Time	Indicates system uptime since last reboot.
System Time	Shows actual time and date according to your configuration.
Service Status	Reveals status of VoIP applications.



Core Dump	Provides generated core dump file when available if unit malfunctions.
------------------	--

DECT Page Definitions

Table 7: DECT Page Definitions

General Settings	
Repeater Name	Configures the name of the repeater station. Default is DP760_[last 6 digit of MAC address] .
Manually Configured Base RFPI	Configures manually RFPI of DP750 base station to connect to. If empty, the repeater station DP760 will search for DP750 base stations and connect automatically to the first one found.
Use Manually Configured RFPI	Allows to use manually configured RFPI (if non-empty) when set to Yes . If set to NO , the DP760 will search for a DP750 to connect with, regardless of manual configuration.

Network Settings

Table 8: Network Settings Pages Definitions

Network Settings – Basic Settings		
IP Address Mode	Selects IP address mode (DHCP, Static IP or PPPoE) for DP760 DECT Repeater.	
Preferred DNS Server	Specifies preferred DNS server to use when DHCP, PPPoE or Static mode is set.	
DHCP Settings	Host name (Option 12)	Specifies the name of the client. The name may or may not be qualified with the local domain name. This field is optional but may be required by ISP.
	Vendor Class ID (Option 60)	Exchanges vendor class ID by clients and servers to convey particular configuration or other identification information about a client. Default is DP7XX .
PPPoE Settings	Configures PPPoE account ID, password and service name.	
Static IP Settings	Sets IP address, subnet mask, gateway, DNS server 1, and DNS server 2.	
Network Settings – Advanced Settings		
802.1X Mode	Enables 802.1X mode. To enable this mode, you should select EAP-MD5. Default is Disable .	



802.1X Identity	Configures the identity for 802.1X mode.	
MD5 Password	Determines the MD5 password for 802.1X mode.	
802.1X CA Certificate	Uploads / deletes the 802.1X CA certificates.	
802.1X Client Certificate	Uploads / Deletes the 802.1X Client Certificates.	
Enable LLDP	Activates LLDP (Link Layer Discovery Protocol). Default is Yes .	
Layer 2 QoS Settings	Enable VLAN	Enables / Disables the VLAN mode. Default is Disabled .
	Layer 2 QoS 802.1Q/VLAN Tag	Sets layer 2 QoS 802.1Q/VLAN tag. Default is 0.
	Layer 2 QoS 802.1p Priority Value for SIP signaling	Sets layer 2 QoS 802.1p priority value for SIP signaling. Default is 0 .
	Layer 2 QoS 802.1p Priority Value for RTP media	Sets layer 2 QoS 802.1p priority value for RTP media. Default is 0 .
UPnP Discovery Settings	Enable UPnP discovery	Enables UPnP discovery feature. Default is Yes .
	UPnP discovery notify interval	Specifies in seconds the interval to send out SSDP notifies. Default is 30 .

Maintenance Page Definitions

Table 9: Maintenance Pages Definitions

Firmware Upgrade	
Firmware Upgrade	Selects how firmware upgrade request will be sent: Always Check for New Firmware, Check New Firmware only when F/W pre/suffix changes, or Always Skip the Firmware Check.
HTTP/HTTPS User	Configures the user name to authenticate with HTTP/HTTPS server.



Name	
HTTP/HTTPS Password	Configures the password to authenticate with HTTP/HTTPS server.
Always send HTTP Basic Authentication Information	Includes configured user name and password in HTTP request before receiving authentication challenge from the server. Default is No .
Verify host when using HTTPS	Verifies host name in server certificate when using HTTPS. Default is Yes .
Upgrade via	Selects firmware upgrade method: FTP, HTTP or HTTPS.
Firmware Server Path	Sets IP address or domain name of firmware server. The URL of the server that hosts the firmware release. Default is fm.grandstream.com/gs .
Firmware File Prefix	Checks if firmware file is with matching prefix before downloading it. This field enables user to store different versions of firmware files in one directory on the firmware server.
Firmware File Postfix	Checks if firmware file is with matching postfix before downloading it. This field enables user to store different versions of firmware files in one directory on the firmware server.
Allow DHCP Option 43 and Option 66 to Override Server	Obtains configuration and upgrade server information from DHCP server using options 66 and 43. Note: If DHCP Option 66 is enabled, the repeater station will attempt downloading the firmware file from the server URL provided by DHCP, even though Firmware Server Path is left blank.
Automatic Upgrade	Specifies when the firmware upgrade process will be initiated; there are 4 options: (Default is No) <ul style="list-style-type: none"> • Yes, check for upgrade at random every X days: User needs to specify a period in days. • No: DP760 DECT Repeater will only do upgrade once at boot up. • Check every X minutes: User needs to specify a period in minutes. • Check every day: User needs to specify Hour of the day (0-23). • Check every week: User needs to specify Hour of the day (0-23) and Day of the week (0-6). <u>Note:</u> Day of week is starting from Sunday.
Firmware Key	Decrypts the firmware file using specified key (32-digit in Hexadecimal) when



	encrypted.
Provisioning	
XML Config File Password	Decrypts XML configuration file when encrypted. The password used for encrypting the XML configuration file is using OpenSSL.
HTTP/HTTPS User Name	Enters user name to authenticate with HTTP/HTTPS server.
HTTP/HTTPS Password	Enters password to authenticate with HTTP/HTTPS server.
Always send HTTP Basic Authentication Information	Includes configured user name and password in HTTP request before receiving authentication challenge from the server. Default is No .
Verify host when using HTTPS	Verifies host name in server certificate when using HTTPS. Default is Yes .
Provisioning via	Selects provisioning method: TFTP, HTTP or HTTPS
Config Server Path	Sets IP address or domain name of configuration server. The server hosts a copy of the configuration file to be installed on the DP760. Default is fm.grandstream.com/gs .
Config File Prefix	Checks if configuration files are with matching prefix before downloading them. This field enables user to store different configuration files in one directory on the provisioning server.
Config File Postfix	Checks if configuration files are with matching postfix before downloading them. This field enables user to store different configuration files in one directory on the provisioning server.
Allow DHCP Option 43 and Option 66 to Override Server	Obtains configuration and upgrade server information from DHCP server using options 66 and 43. Note: If DHCP Option 66 is enabled, DP760 will download firmware file from the server URL provided by DHCP, even though Config Server Path is left blank.
Automatic Provisioning	Specifies when provisioning process will be initiated; there are 4 options: <ul style="list-style-type: none"> • No: Repeater station will only request configuration files once at boot up. • Check every X minutes: User needs to specify a period in minutes. • Check every day: User needs to specify Hour of the day (0-23). • Check every week: User needs to specify Hour of the day (0-23) and Day



	<p>of the week (0-6). <u>Note:</u> Day of week is starting from Sunday.</p> <p>Default is No.</p>	
Authenticate Conf File	<p>Authenticates configuration file before being accepted. This protects the device configuration from unauthorized modifications. Default is No.</p>	
Upload Device Config	<p>Uploads manually device configuration to repeater station; files both in TXT and XML format are supported.</p>	
Device Config (TXT)	<p>Downloads actual device configuration file in .txt format.</p>	
Device Config (XML)	<p>Downloads default device configuration file in .xml format.</p>	
Backup Configuration	<p>Generates and downloads backup files configuration by clicking on Backup Settings button.</p>	
Web/SSH Access		
New Password	<p>Configures user level password. Case sensitive and max length is 30 characters.</p>	
Confirm Password	<p>Configures the new user password again to confirm.</p>	
New Password	<p>Configures admin level password. Case sensitive and max. length is 30 characters.</p>	
Confirm Password	<p>Configures the new admin password again to confirm.</p>	
Access Control Lists	White list for WAN side	<p>If white list exists, then only these IP addresses are allowed for Web and SSH access.</p>
	Black list for WAN side	<p>If black list exists and white list is empty, then only these IP addresses are not allowed for Web and SSH access.</p>
Web/SSH Settings		
HTTP Web Port	<p>Customizes HTTP port used to access repeater Web GUI. Default is 80.</p>	
HTTPS Web Port	<p>Customizes HTTPS port used to access repeater Web GUI. Default is 443.</p>	
Web Access Mode	<p>Determines the protocol to be used for the Web GUI access. Default is HTTP.</p>	
Disable SSH	<p>Disables SSH access. Default is No.</p>	
SSH Port	<p>Customizes SSH access port. Default is 22.</p>	



Date and Time	
NTP Server	Defines URL or IP address of the NTP (Network Time Protocol) server. Used by the repeater to synchronize the date and time. A list of public NTP servers can be found at http://www.ntp.org .
NTP Update Interval	Contacts NTP server at specified period of time (in minutes) to obtain the date and time. Default is 60 minutes.
Allow DHCP Option 42 to NTP Server	Obtains NTP server address from a DHCP server using DHCP Option 42; it will override configured NTP Server. If set to <i>No</i> , the repeater will use configured NTP server to synchronize time and date even if a NTP server is provided by DHCP server. Default is Yes .
Time Zone	Selects time zone to define date/time on the repeater station.
Self-Defined Time Zone	Allows users to define their own time zone.
Allow DHCP Option 2 to override time zone	Obtains time zone setting (offset) from a DHCP server using DHCP Option 2; it will override selected time zone. If set to <i>No</i> , DP760 DECT repeater will use selected time zone even if provided by DHCP server. Default is Yes .
Syslog	
Syslog Server	Sets IP address or URL of system log server. The server collects system log information from the repeater station.
Syslog Level	<p>Selects log level; the level is one of DEBUG, INFO, WARNING, ERROR (default is NONE). Syslog messages are sent based on the following events:</p> <ol style="list-style-type: none"> 1. product model/version on boot up (INFO level) 2. NAT related info (INFO level) 3. sent or received SIP message (DEBUG level) 4. SIP message summary (INFO level) 5. inbound and outbound calls (INFO level) 6. registration status change (INFO level) 7. negotiated codec (INFO level) 8. Ethernet link up (INFO level) 9. SLIC chip exception (WARNING and ERROR levels) 10. memory exception (ERROR level) <p>Syslog uses USER facility. In addition to standard Syslog payload, it contains the following components: GS_LOG: [device MAC address] [error code] error</p>



	message. <i>Example:</i> May 19 02:40:38 192.168.1.14 GS_LOG:[00:0b:82:00:a1:be][000] Ethernet link is up	
Packet Capture		
Status	Displays packet capture status. When user starts to capture trace file, it will show RUNNING status, otherwise, it will show STOPPED .	
Factory Reset		
Force Reboot	Forces rebooting DP760 DECT repeater. Note: The DP760 will reboot even if there is an active call.	
Configure Web GUI Button	Reset Type	Specifies the type of reset to perform via the Web GUI button. - There are 2 reset type for Web GUI button: <ol style="list-style-type: none"> 1. Full Factory Reset: Reset all the settings. 2. NVRAM Settings Only: Reset all the settings except subscription information, and all the other settings like provisioning settings, audio settings, etc., will be reset. Default setting is Full Factory Reset .
	Perform Selected Reset	Press Reset to restore the factory default settings on the DP760.
Configure Hardware Button	Reset Type	Specifies the type of reset to perform via the hardware button on the device. There are 3 reset types for hardware button: <ol style="list-style-type: none"> 1. Full Factory Reset: Reset all the settings. 2. NVRAM Settings Only: Reset all the settings except subscription information, and all the other settings like provisioning settings, audio settings, etc., will be reset. 3. Disabled: Disable the hardware button to factory reset the base for security purpose. Default setting is Full Factory Reset .
Support		
Support Documentation	Online Support	Redirects the users to tools page and DP7xx product pages available on Grandstream official Website.
	Offline	Allows users to download MD Hole Location for wall mount.



	Support	
Debug Tool	Remote Log Submission - Terms & Conditions	By clicking the submit button, you agree to allow the device to send these files to Grandstream to be used for troubleshooting purposes. If possible, please include a comment with information regarding the use of the device when the problem occurred. As an alternative to the device submitting the files, you may download the files below and submit them to Grandstream manually.
	Debug Log Files	Kills device control process on DECT repeater and generates core file and other debug information. Reboot required to restart process.

Rebooting from Remote Location

Press the **Reboot** button on the top right corner of the Web GUI page to reboot the DP760 remotely. The Web browser will then display a reboot message to confirm the reboot by pressing **OK** or avoid by clicking on **Cancel** button. Wait for about 1 minute to log in again.

DP760 DECT REPEATER ASSOCIATION WITH DP750

After factory reset, DP760 will be set to “Auto-region” mode. In this mode, the three LEDs of right side keep quick blinking, then the DP760 will search the base signal in the current environment to auto associate with it and then auto switch to the same region (EU, US or BR) of the base station.

Enabling Repeater Mode on DP750

Before associating the DP760 DECT Repeater to your DP750 Base Station, you should firstly enable the repeater mode on your base station. Please refer following steps to enable the repeater mode on the DP750 base station:

1. Access the Web GUI of your DP750 using the admin’s username and password. (Starting HW version 1.7A the default admin username is ‘admin’ while the admin password is the random password that can be found on the sticker at the back of the unit. For lower hardware versions; the default username and password are: admin/admin).
2. Navigate to **DECT** → **General Settings** and set **Enable Repeater Mode** to **Yes**.

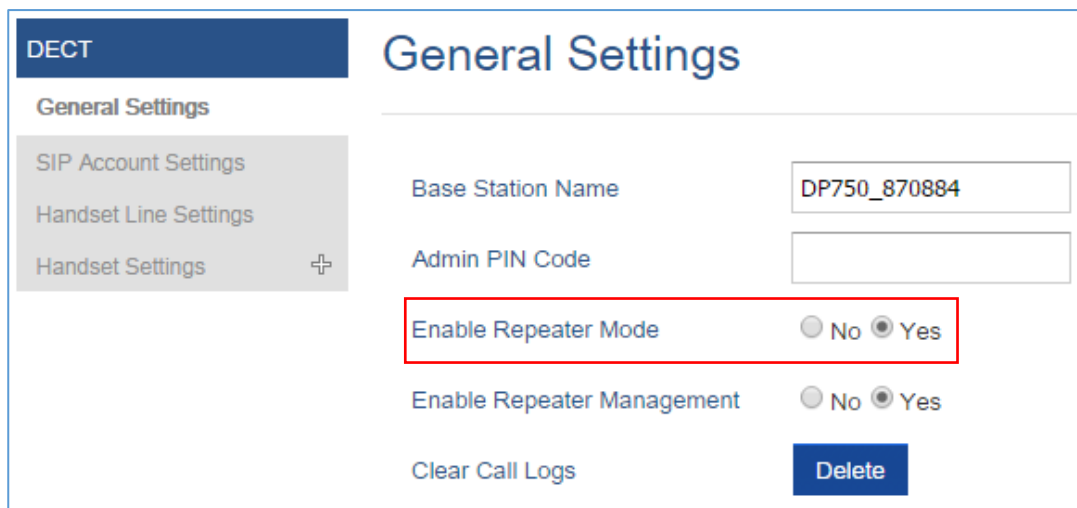

Figure 10: Enable Repeater Mode

3. Press **Save and Apply**, then **Reboot** the base to apply the new settings.

DP760 DECT Repeater Association

After enabling the repeater mode on DP750 Base Station, you can easily associate it with your DP760 DECT Repeater using one of the following methods:

- **Auto Association**
- **Manual Association**
- **Use DP750 Repeater Management to associate DP760**

Note: Using auto/manual association methods, the DP760 repeater will not be listed on DP750 “DECT Repeater Status” page even if “Repeater Management Mode” is enabled on DP750.

Auto Association

To auto associate your DP760 DECT Repeater with DP750 Base Station:

1. Please put the DP760 DECT Repeater close to DP750, then power on the DP760.
2. After the DP760 finish booting, the association LED  will be blinking to indicate that the repeater is searching for nearby base stations.

Note: If all the LEDs remain on, it indicates that the DP760 Repeater has successfully associated with a DP750 Base and ready for use. You may need to dissociate it before continuing (Please refer to [DP760 DECT REPEATER DISSOCIATION]).

3. Open subscription on your DP750 Base Station using one of following methods:
 - Rebooting the Base station.
 - Long press on page/subscribe button on the back panel of DP750 for 7 seconds.
 - Access DP750 Web GUI and press subscribe button .
4. The DP760 DECT Repeater will automatically pair to DP750. Upon successful association with the DP750 Base station all LEDs will turn ON and the repeater status will be updated as following.

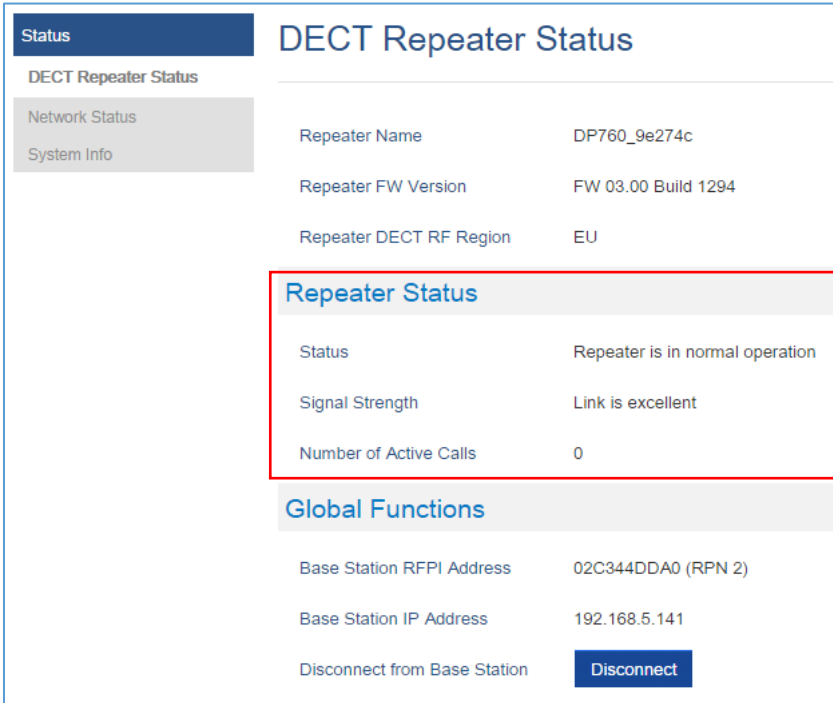

The screenshot shows the 'DECT Repeater Status' page. On the left, there is a navigation menu with 'Status' selected, and sub-items for 'DECT Repeater Status', 'Network Status', and 'System Info'. The main content area is titled 'DECT Repeater Status' and contains the following information:

Repeater Name	DP760_9e274c
Repeater FW Version	FW 03.00 Build 1294
Repeater DECT RF Region	EU
Repeater Status	
Status	Repeater is in normal operation
Signal Strength	Link is excellent
Number of Active Calls	0
Global Functions	
Base Station RFPI Address	02C344DDA0 (RPN 2)
Base Station IP Address	192.168.5.141
Disconnect from Base Station	<input type="button" value="Disconnect"/>

Figure 11: Repeater Status – Associated (Auto Association)

Notes:

- For auto association, the option **Use manually configured RFPI** under DP760 Web GUI should be disabled (by default disabled).
- The association may take up to a few minutes. Time will vary depending on the number of DP760.

Manual Association

To manually associate your DP760 DECT Repeater to your DP750 Base Station:

1. Access the Web GUI of your DP760 using the admin's username and password. (Starting HW version 1.3A the default admin username is 'admin' while the admin password is the random password that can be found on the sticker at the back of the unit. For lower hardware versions; the default username and password are: admin/admin). Refer to [**Accessing the Web GUI**]
2. Navigate to **DECT → General Settings** and set **Use Manually Configured RFPI** to **Yes**.
3. On **Manually Configured Base RFPI** field, configure your DP750 Base Station RFPI address.

Note: The RFPI Address of your DP750 Base Station is available under the Web GUI → **Status → DECT Status → Base DECT RFPI Address**.

4. Click **Save and Apply** to confirm the new settings.
5. Go to DECT Repeater Status page and click on "Manual-Lock to xxxxxxxxxx".
6. The DP760 DECT Repeater will automatically pair to DP750. If the association is correctly associated, all the LEDs will remain solid on and the repeater status will be updated as following.



Status

DECT Repeater Status

DECT Repeater Status

Network Status

Repeater Name: DP760_9e274c

System Info

Repeater FW Version: FW 03.00 Build 1294

Repeater DECT RF Region

EU

Repeater Status

Status	Repeater is in normal operation
Signal Strength	Link is excellent
Number of Active Calls	0

Global Functions

Base Station RFPI Address

02C344DDA0 (RPN 2)

Base Station IP Address

192.168.5.141

Disconnect from Base Station

Disconnect

Figure 12: Repeater Status – Associated (Manual Association)

Note: Make sure that **Repeater Mode** is enabled on your DP750 Base Station.

Use DP750 Repeater Management to Associate DP760

The repeater management mode on the DP750 allows to associate, dissociate and manage discovered and paired repeater stations from DP750 web GUI.

❖ Enabling Repeater Management Mode

The following steps illustrate how to enable and use the Repeater Management mode on DP750:

1. Access the Web GUI of your DP750 using the admin's username and password. (Starting HW version 1.7A the default admin username is 'admin' while the admin password is the random password that can be found on the sticker at the back of the unit. For lower hardware versions; the default username and password are: admin/admin).
2. Navigate to **DECT → General Settings** and set **Enable Repeater Management** to **Yes**.
3. Press **Save and Apply**, then reboot the unit to apply the new settings.

DECT

General Settings

General Settings

- SIP Account Settings
- Handset Line Settings
- Handset Settings
- HS1 Settings
- HS2 Settings
- HS3 Settings
- HS4 Settings
- HS5 Settings

Base Station Name

Admin PIN Code

Enable Repeater Mode No Yes

Enable Repeater Management No Yes

Clear Call Logs Delete

Handset Settings

Handset	Handset Name	Handset Phonebook	Offhook Auto-dial
HS1	<input style="width: 100%;" type="text" value="HS1"/>	<input style="width: 100%;" type="text" value="PB1"/> ▼	<input style="width: 100%;" type="text"/>
HS2	<input style="width: 100%;" type="text" value="HS2"/>	<input style="width: 100%;" type="text" value="PB2"/> ▼	<input style="width: 100%;" type="text"/>
HS3	<input style="width: 100%;" type="text" value="HS3"/>	<input style="width: 100%;" type="text" value="PB3"/> ▼	<input style="width: 100%;" type="text"/>
HS4	<input style="width: 100%;" type="text" value="HS4"/>	<input style="width: 100%;" type="text" value="PB4"/> ▼	<input style="width: 100%;" type="text"/>
HS5	<input style="width: 100%;" type="text" value="HS5"/>	<input style="width: 100%;" type="text" value="PB5"/> ▼	<input style="width: 100%;" type="text"/>

Save
Save and Apply
Reset

Figure 13: Repeater Associated Status

❖ **Associating DP760 using Repeater Management Mode on DP750**

The repeater management mode displays discovered and paired devices using their name, IP and Mac addresses and also gives the possibility of associating the DP750 Base Station with DP760 DECT Repeater. Please refer to following steps in order to associate DP760 with DP750 using repeater management mode.

1. Access the Web GUI of your DP750 using the admin's username and password. (Starting HW version 1.7A the default admin username is 'admin' while the admin password is the random password that can be found on the sticker at the back of the unit. For lower hardware versions; the default username and password are: admin/admin).
2. Navigate to **Status** → **DECT Repeater Status** and select the repeater station from **Discovered Devices**.
3. Click **Link** button to associate the base and repeater stations.

Note: The DP760 Repeater stations associated with DP750 Base Station are displayed and available under **Status** → **DECT Repeater Status** → **Paired Devices** with their status, signal strength, number of active calls and also the ability to disconnect them from the paired base station.

Status

Account Status

DECT Base Status

DECT Repeater Status

Line Options

Network Status

System Info

DECT Repeater Status

Paired Devices

Discovered Devices

Model	Name	IP	MAC	Link
DP760	DP760_8b556b	192.168.5.125	000b828b556b	Link

Figure 14: DECT Repeater Status on DP750

DP760 DECT REPEATER DISSOCIATION

To disconnect DP760 DECT Repeater from the Base Station DP750, please refer to following options:

Using DP760 Web GUI

To disconnect your DP760 DECT Repeater via Web GUI, please refer to following steps:

1. Access the Web GUI of your DP760 using the admin's username and password. (Starting HW version 1.3A the default admin username is 'admin' while the admin password is the random password that can be found on the sticker at the back of the unit. For lower hardware versions; the default username and password are: admin/admin).
2. Navigate to **Status** → **DECT Status** → **Global Functions** and press **Disconnect**.
3. The DP760 DECT Repeater will be automatically disconnected from the DP750 and it will start again scanning for available RFPs.

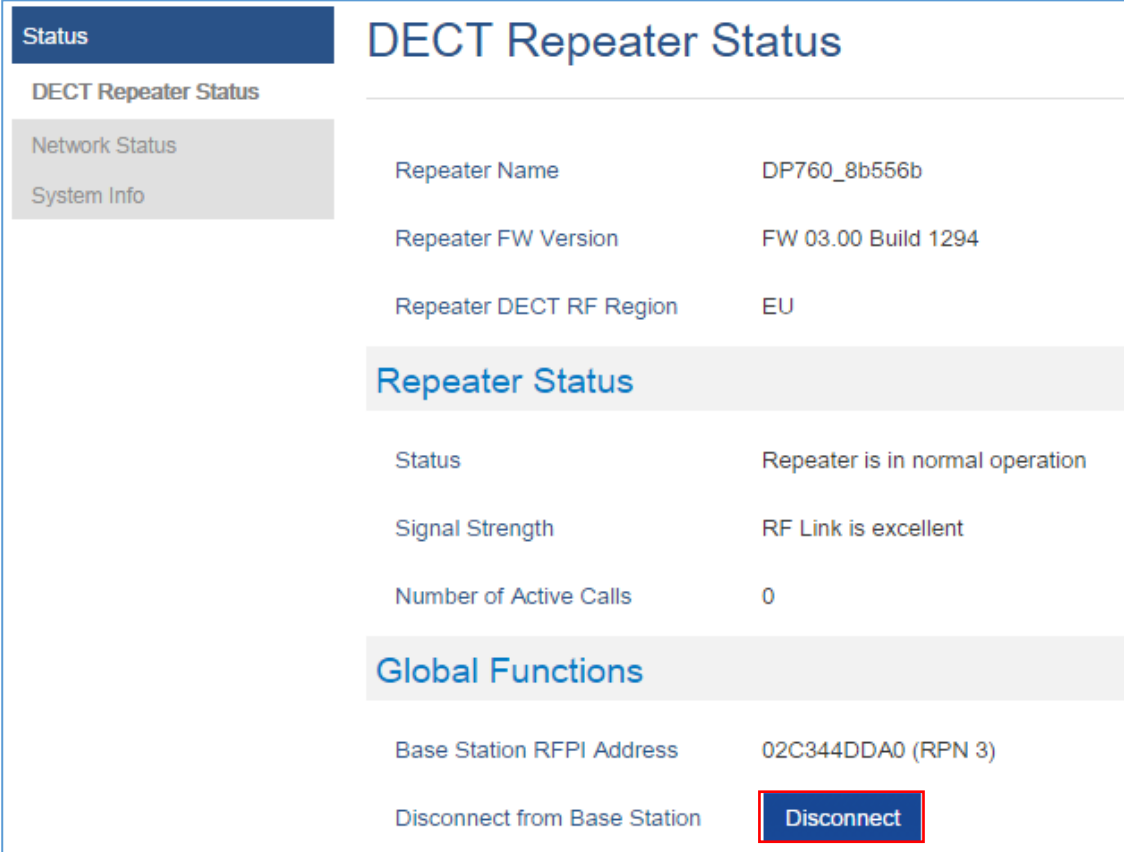

The screenshot displays the 'DECT Repeater Status' page in the web GUI. On the left, there is a navigation menu with 'Status' selected, and sub-items for 'DECT Repeater Status', 'Network Status', and 'System Info'. The main content area is titled 'DECT Repeater Status' and contains the following information:

Repeater Name	DP760_8b556b
Repeater FW Version	FW 03.00 Build 1294
Repeater DECT RF Region	EU

Below this is a section titled 'Repeater Status' with the following details:

Status	Repeater is in normal operation
Signal Strength	RF Link is excellent
Number of Active Calls	0

The next section is 'Global Functions', which includes:

Base Station RFPI Address	02C344DDA0 (RPN 3)
Disconnect from Base Station	Disconnect

Figure 15: DECT Repeater Status on DP750

Using Page Button

Long press on page button on the back panel of DP760 for 7 seconds, it will remove the association values of the previous base station.

Using Repeater Management Mode on DP750

To disconnect your DP760 DECT Repeater using the repeater management mode on DP750:

1. Access the Web GUI of your DP750 using the admin's username and password. (Starting HW version 1.7A the default admin username is 'admin' while the admin password is the random password that can be found on the sticker at the back of the unit. For lower hardware versions; the default username and password are: admin/admin).
2. Navigate to **Status** → **DECT Repeater Status**.
3. Select the repeater station from **Discovered Devices**.
4. Click **Unlink** button to dissociate the repeater from the base station.

Status		DECT Repeater Status							
Account Status									
DECT Base Status									
DECT Repeater Status		Paired Devices							
Line Options		Model	Name	IP	MAC	Status	Signal Strength	Active Calls	Unlink
Network Status		DP760	DP760_8b556b	192.168.5.125	000b828b556b	online	RF Link is excellent	0	Unlink
System Info									

Figure 16: DECT Repeater Status on DP750

UPGRADING AND PROVISIONING

The DP760 DECT Repeater can be upgraded via FTP/FTPS/HTTP/HTTPS by configuring the URL/IP Address for the FTP/FTPS/HTTP/HTTPS server and selecting a download method. Configure a valid URL for FTP/FTPS/HTTP/HTTPS ; the server name can be FQDN or IP address.

Examples of valid URLs:

firmware.grandstream.com

fw.ipvideotalk.com/gs

Firmware Upgrade Procedure

Please follow below steps in order to upgrade the firmware version of your DP760 repeater station:

1. Access the Web GUI of your DP760 using the admin's username and password. (Starting HW version 1.3A the default admin username is 'admin' while the admin password is the random password that can be found on the sticker at the back of the unit. For lower hardware versions; the default username and password are: admin/admin).
2. Navigate to **Maintenance** → **Firmware Upgrade** page, enter the IP address or the FQDN for the upgrade server in **Firmware Server Path** field and choose to upgrade via FTP/FTPS/HTTP/HTTPS.
3. Make sure to select **Always Check for New Firmware**.
4. Update the change by clicking the **Save and Apply** button. Then reboot or power cycle the device to update the new firmware.



Maintenance

Firmware Upgrade

Base Firmware

Firmware Upgrade Always Check for New Firmware
 Check New Firmware Only When F/W pre/suffix Changes
 Always Skip the Firmware Check

HTTP/HTTPS/FTP/FTPS User Name

HTTP/HTTPS/FTP/FTPS Password

Always send HTTP Basic Authentication Information No Yes

Verify host when using SSL No Yes

Upgrade via HTTP HTTPS FTP FTPS

Firmware Server Path

Firmware File Prefix

Firmware File Postfix

Allow DHCP Options 43, 66 and 160 to override Server No Yes

Automatic Upgrade No
 Yes, check for upgrade at random every day(s)
 Yes, check for upgrade every minute(s)
 Yes, check for upgrade every day
 Yes, check for upgrade every week

Random Interval Start Time :

Random Interval Stop Time :

Hour of the Day(0-23)

Day of the Week (0-6)

Firmware Key

Upgrade

Handset Firmware

Handset firmware

Automatic Upgrade No Yes

Figure 17: Firmware Upgrade Page

Upgrading via Local FTP/HTTP Servers

For users that would like to use remote upgrading without a local FTP/HTTP server, Grandstream offers a



NAT-friendly HTTP server. This enables users to download the latest software upgrades for their devices via this server. Please refer to the webpage: <http://www.grandstream.com/support/firmware>

Alternatively, users can download a free FTP or HTTP server and conduct a local firmware upgrade. A free windows version FTP server is available for download from:

<https://filezilla-project.org/download.php?type=server>

Instructions for local firmware upgrade via FTP:

1. Unzip the firmware files and put all of them in the root directory of the FTP server.
2. Connect the PC running the FTP server and the phone to the same LAN segment.
3. Start the FTP server and configure the FTP server in the phone's web configuration interface.
4. Configure the Firmware Server Path to the IP address of the PC.
5. Configure the Admin and password authentication Credentials set on your FTP server.
6. Save and apply the changes and reboot the base station.

End users can also choose to download a free HTTP server from <http://httpd.apache.org/> or use Microsoft IIS web server.



RESTORE FACTORY DEFAULT SETTINGS

Warning:

Restoring the Factory Default Settings will delete all configuration information on the repeater. Please backup or print all the settings before you restore to the factory default settings. Grandstream is not responsible for restoring lost parameters and cannot connect your device to your VoIP service provider.

Resetting DP760 Repeater Station

There are two methods to reset your DP760 DECT Repeater to the default settings:

Via Reset Button

1. Locate the reset hole on the back panel of your DP760.
2. Insert a pin in this hole, and press for about 7 seconds.
3. Take out the pin. The unit will restart automatically with parameters restored to default values.

Note: A quick press on the reset hole will only reboot the unit.

Via Web GUI

1. Access your DP760 DECT Repeater Web GUI.
2. Enter your admin's username and password. (Starting HW version 1.3A the default admin username is 'admin' while the admin password is the random password that can be found on the sticker at the back of the unit. For lower hardware versions; the default username and password are: admin/admin)
3. Press **Login** to access and navigate to **Maintenance** → **Factory Reset**.
4. Press Reset button and the unit will prompt a confirmation message, press **OK** to reset the repeater, then the unit restart automatically with parameters restored to default values or press **Cancel** to annul the reset.



EXPERIENCING THE DP760

Please visit our Website: <http://www.grandstream.com> to receive the most up- to-date updates on firmware releases, additional features, FAQs, documentation and news on new products.

We encourage you to browse our [product related documentation](#), [FAQs](#) and [User and Developer Forum](#) for answers to your general questions. If you have purchased our products through a Grandstream Certified Partner or Reseller, please contact them directly for immediate support.

Our technical support staff is trained and ready to answer all of your questions. Contact a technical support member or [submit a trouble ticket online](#) to receive in-depth support.

Thank you again for purchasing Grandstream DP760 DECT Repeater, it will be sure to bring convenience to both your business and personal life.

